

DGV10J-01P-1Y-00A(H)

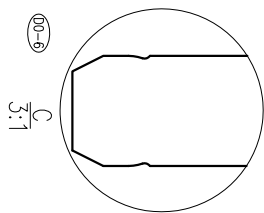

公差/General	公差/General tolerances(mm)											公差/Tolerance	
0	>3	>6	>10	>18	>30	>50	>80	>120	>180	>250	>315	>400	0.1/10
~	~	~	~	~	~	~	~	~	~	~	~	~	±Z
±0.12	±0.18	±0.22	±0.26	±0.31	±0.37	±0.57	±0.80	±0.93	±1.05	±1.15	±1.60	±2.20	±2.50

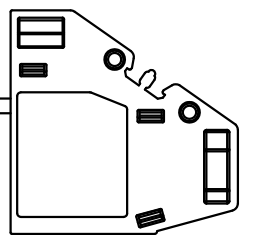
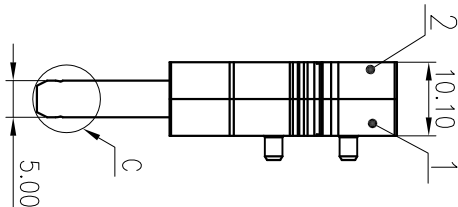
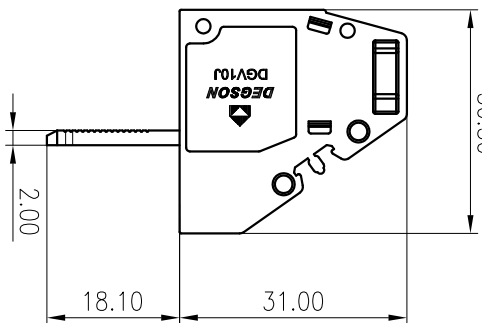
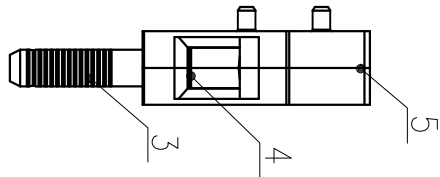
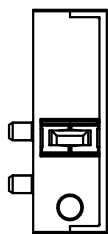

DGV10K-01P-1Y-00A(H)

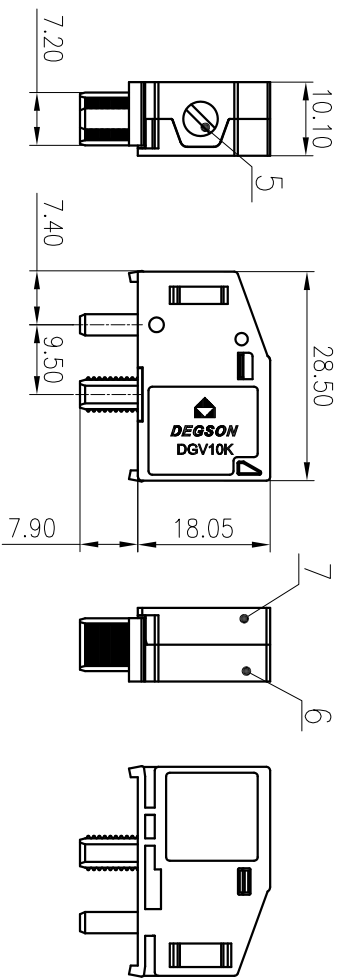
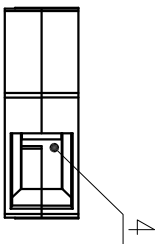

7	DGV10K	HOUSING2	PA66	UL94V-0
6	DGV10K	HOUSING1	PA66	UL94V-0
5		Screw	Steel	Zn Plated
4		Cage	CopperAlloy	Ni Plated
3		Current Carrier	Copper	Sn Plated
2	DGV10J	HOUSING2	PA66	UL94V-0
1	DGV10J	HOUSING1	PA66	UL94V-0
ITEM	NAME	OF PART	MATERIAL	NOTES
UL 标准/UL Standard:	B	C	D	
额定电压/Rated Voltage(V)/Current(A)	300/65	150/65	300/10	
EC 标准/EC Standard:				
过压类别/Overvoltage Category/污染等级	III/3	/	/	
额定电压/电流/Rated Voltage(V)/Current(A)	400/57	/	/	
额定脉冲电压(KV)/Rate Impulse Voltage(KV)	6	/	/	
螺丝扭矩/Torque Tightening(N·m/Lb·in)	M4, 1.2/10.53			
线缆范围(硬线和软线)/Wire Range(rigid and flexible)(mm ² /AWG)	0.5~10(16sol)/24~6			
间距/Pitch(mm)/线数范围/Poles	10.1/N=01P			
剥线长度/Stripping length(mm)	10~11			
使用温度范围/Operating temperature(°C)	-40~+105			
符合RoHS环保要求/Conform to RoHS	Yes			
标准颜色编号/Standard color number:	- / -			
PANTONE / RAL				
SURFACE: /				

MATERIAL: /

MAT NO.: /

STATUS: /

APPD: /

CHKD: /

DRT: Apple

SIZE: A4

NAME: DGV10-01P-1Y-00A(H)

NINGBO DEGSON ELECTRICAL CO., LTD

10002101

1/1

SCALE: 1/1

1/1

1/1

1/1